



Our Environment, Our Energy, Our Future



User Manual

UB 5000 Lithium Battery Storage

About UB 5000 battery

UB 5000 battery can be installed in Parallel and Series mode, more attention should be paid for the DIP and address selection following with part 5.3.2.

About this manual

This manual is intended for the UB 5000 Energy Storage battery, but the hybrid inverter and any other equipment is not included. If you want to get additional information, please visit <http://www.ouco.com>

Contents

About UB 5000 battery	
About this manual	
Declaration	
1. Safety introduction	- 1 -
1.1 Important Safety Instructions	- 1 -
1.2 Warnings in this Document	- 1 -
1.3 Battery handing guide	- 1 -
1.4 Response to emergency situations	- 2 -
1.5 Installers	- 3 -
1.6 APP download	- 3 -
1.7 Scrap battery	- 3 -
2. Product Introduction	- 4 -
2.1 Technical data	- 4 -
2.2 Exploded views of battery	- 4 -
2.3 Indicator and ports	- 6 -
2.4 Communication interface plat (DVC-A ₂ voltage)	- 6 -
2.5 How it works	- 6 -
2.6 Feature	- 7 -
3. Guidance for disconnection of batteries during shipment	- 8 -
4. Installation Prerequisites	- 9 -
4.1 Installation location	- 9 -
4.2 Installation requirements	- 9 -
4.3 Installation process	- 9 -
4.4 Installation materials	- 10 -
4.5 Tools	- 10 -
4.6 Safety instruments	- 11 -
4.7 Network cable	- 11 -

4.8	Storage	11
5.	Battery Installation	13
5.1	Package items	13
5.2	Checks before installation	13
5.3	Installation the battery	13
5.3.1	Connect with 48Vdc Inverter	13
5.3.2	Address select of Master and Slave battery(ies) connection	15
5.4	Cable connections	19
5.4.1	Cable connection for Series connection	19
5.4.2	Cable connection for Parallel connection	20
6.	Configuration	22
6.1	Configure device WIFI	22
6.2	Register your account	23
6.3	Settings for CAN /485 bus pins	24
7.	Commissioning	26
7.1	Commissioning battery	26
7.2	Shutting down battery	26
8.	Troubleshooting	27
9.	Firmware Update	28

1. Safety introduction

1.1 Important Safety Instructions

This manual contains important instructions for:







UB 5000 Energy Storage product

and this manual must be followed when installing and using this product.

The product is designed and tested in accordance with international safety requirements IEC 60364, but as with all electrical and electronic equipment, certain precautions must be observed when installing and/or operating the product. To reduce the risk of personal injury and ensure the safe installation and operation of the product, you must carefully read and follow all instructions, cautions and warnings in this manual.

1.2 Warnings in this Document

A warning describes a hazard to equipment or personnel. It calls attention to a procedure or practice, which, if not correctly performed or adhered to, could result in damage to or destruction of part or all of the equipment and/or other equipment connected to the equipment or personal injury.

Symbol	Description
	Caution, risk of electric shock
	Heavy enough may cause severe injury
	Keep the battery away from open flame or ignition sources
	Keep the battery away from children
	Do not dispose of the product with household waste
	Recycling
	Read this manual before installation and operation

For safety reasons, installers are responsible for familiarizing themselves with the contents of this manual and all warnings before performing installation.

1.3 Battery handling guide

- Use the battery pack only as directed.
- If the battery defective, appears cracked, broken or otherwise damaged, or fails to operate, contract the your distributor immediately.
- Do not attempt to open, disassemble, repair, tamper with, or modify the battery. The battery pack is not user serviceable.
- To protect the battery and its components from damage when transporting, handle with care.
- Do not subject it to any strong force.

- Do not insert foreign objects into any part of the battery pack.
- Do not use cleaning solvents to clean the battery.
- The battery shall not be connected directly to SELV circuit.

1.4 Response to emergency situations

The UB battery is designed with multiple safety strategies to prevent hazards resulting from failures. However, Ouco cannot guarantee their absolute safety for uncertain situations.

1.4.1 Leaking batteries

If the battery pack leaks electrolyte, avoid contact with the leaking liquid or gas. Electrolyte is corrosive and contact may cause skin irritation and chemical burns. If one is exposed to the leaked substance, do these actions:

Inhalation: Evacuate the contaminated area, and seek medical attention immediately.

Eyes contact: Rinse eyes with flowing water for 15 minutes, and seek medical attention immediately.

Skin contact: Wash the affected area thoroughly with soap and water, and seek medical attention immediately.

Ingestion: Induce vomiting as soon as possible, and seek medical attention immediately.

1.4.2 Fire

In case of a fire, make sure that an ABC or carbon dioxide extinguisher is nearby and does not use water to extinguish the fire.



WARNING

The battery pack may catch fire when heated above 130°C.

If a fire breaks out where the battery is installed, do these actions:

1. Extinguish the fire before the battery catches fire.
2. If the battery has caught fire, do not try to extinguish the fire. Evacuate people immediately.

WARNING

If the battery catches fire, it will produce poisonous gases. Do not approach.

1.4.3 Wet battery

If the battery is wet or submerged in water, do not try to access it. Contact your distributor for technical assistance.

1.4.4 Damaged battery

If the battery damaged, please contract your distributor for help as soon as possible, because damaged battery is dangerous and must be handled with extreme caution.

Damaged battery is not suit for use and may pose a danger to people or property. If the battery seems to be damaged, return it to your distributor.

CAUTION

Damaged battery might export electrolyte or flammable gas, so contact your distributor for advice and information immediately we will deal with it within 48h.

1.5 Installers

UB Energy Storage battery is suggested installing by skilled worker or electrician. A skilled worker is defined as a people who had been trained and qualified electrician or had all of the following skills and experience:

- Knowledge of the functional principles and operation of on-grid Energy Storage systems.
- Knowledge of the dangers and risks associated with installing and using electrical devices and acceptable mitigation methods.
- Knowledge of the installation of electrical devices
- Knowledge of and adherence to this manual and all safety precautions and best practices.

1.6 APP download

Ouco Energy storage battery monitor App could be downloaded by <http://www.ouco.com/app> or scanning this bar code with your smart phone.



1.7 Scrap battery

For scrap battery(-ies), please treat with local laws or regulations to recycle or scrap.

2. Product Introduction

2.1 Technical data

Model		UB 5000
Total Energy*		5.1kWh
Usable Energy(DC)*		4.8kWh
Nominal Charge/Discharge Power		3.0kW
Peak Power(Only discharge)		6.0kW for 3 seconds
Constant Current(Only discharge)		80A
Voltage		48~56Vd.c
Nominal Voltage		51.2Vd.c
Nominal Current		60A
Rated Capacity		100Ah
Max. Charge Voltage		57.6V
Max. Recommended DOD (Off-grid)		90%
Operating Condition		Indoor
Operating Temperature	Charge	From 0~50°C
	Discharge	From -10~55°C
Dimension(L*W*H)		500*442*133 mm
WIFI Frequency Range		2400MHz~2483MHz
Max. Transmission Power		<20dBm
Weight		45kg
Humidity		< 60% (No Condensed Water)
Pollution Degree		3
Over Voltage Category		II
Cooling Type		Natural cooling
Case Material		Metal
Color		Black or Grey
Installation		Wall Mounting/ Ground Installation
IP rating		IP 20
Protective Class		I
Max. Number of Parallel or Series		8S/4P
Warranty		10 years
Communication		CAN/ RS485
Protection Mode		Dual hardware protection
Battery Protection		Over-current/Over-voltage/Short circuit/ Under-voltage/Over temperature
Safety	Cell UL1973	
	Pack TUV(IEC 62619)	
Hazardous Material Classification		9
Transportation		UN 38.3

Testing conditions based on temperature 25°C at the beginning of life.

*Total Energy/Usable Energy measured under specific conditions from UB 0.2C CC-CV

2.2 Exploded views of battery

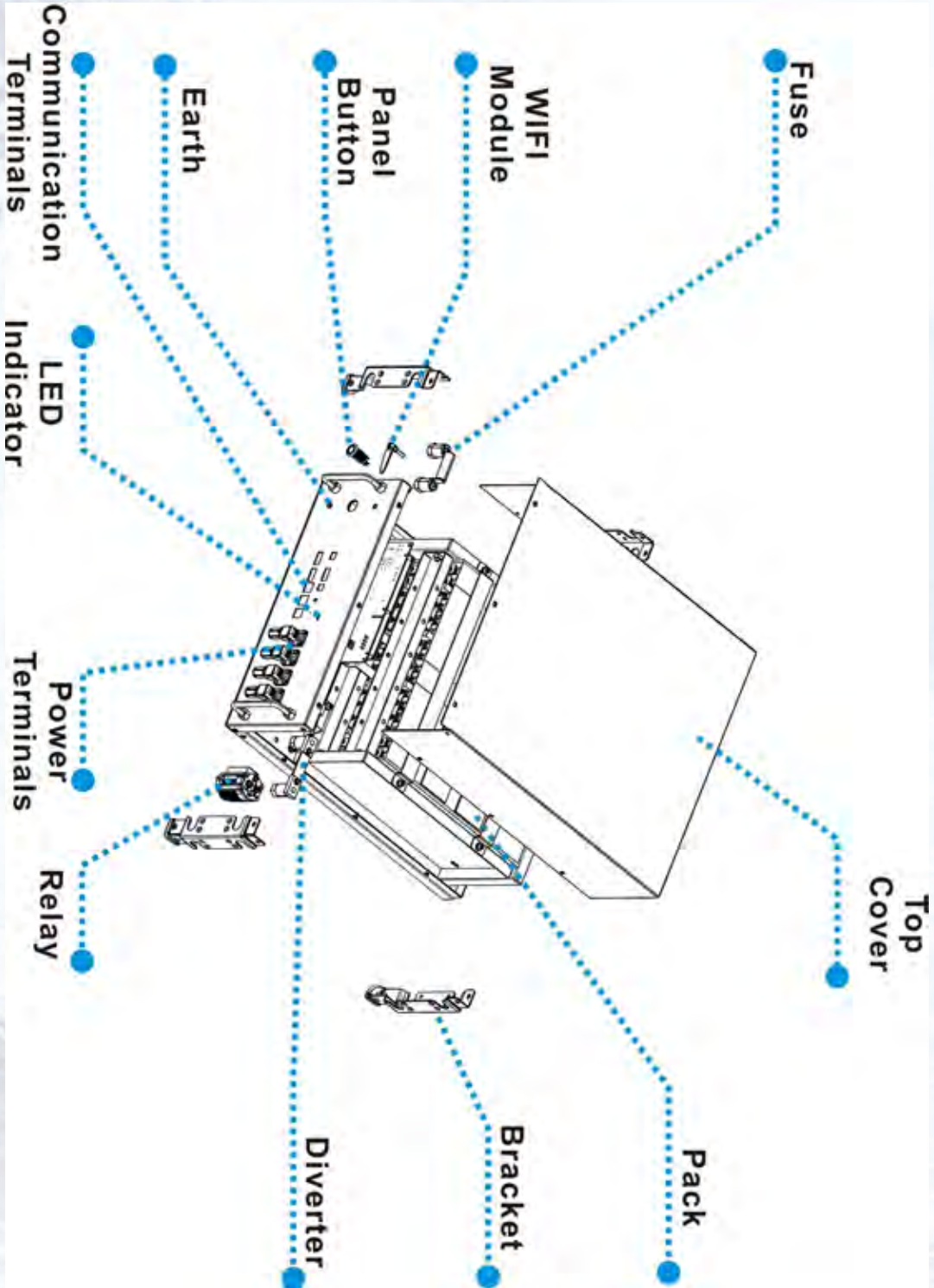

2.3 Indicator and ports

2.3.1 Indicator

There are two LED indicators on the front of the battery to show its operating status.

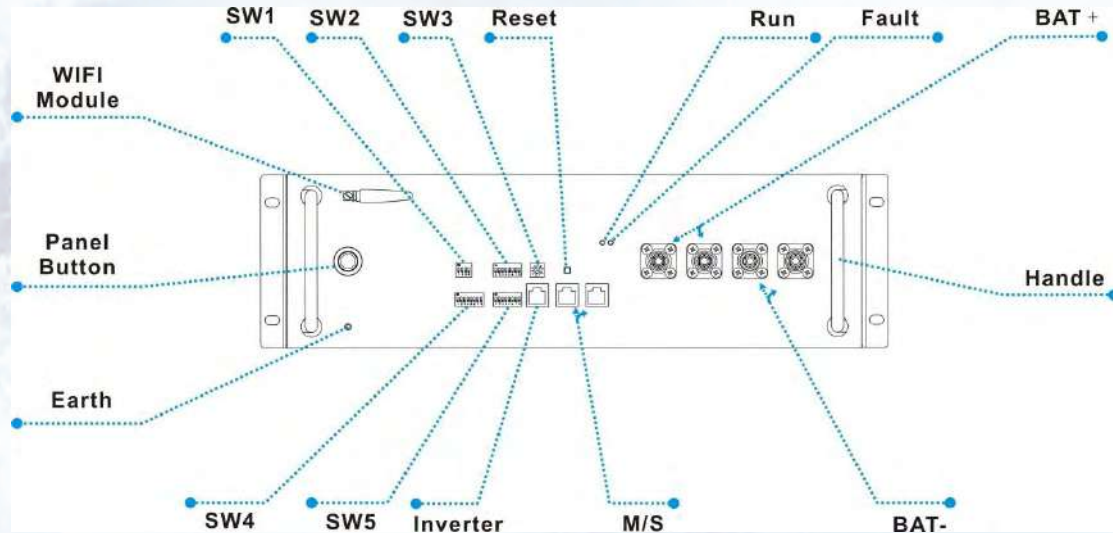

Table 2-1 Designations on the battery

Item	Designation	Definition
1	Running	Battery normally working without fault
2	Fault	Battery is in a warning state, see troubleshooting in Chapter 6

2.4 Communication interface plat (DVC-A₂ voltage)



SW1	DIP switch select for CAN or RS485
SW2	Resistance for communication and DIP switch for parallel or Series connection
SW3	Switch for battery's Address select
SW4 & SW5	Communication interface for battery or master battery with Inverter
Reset	Reset the WIFI or GPPS/GPS module configure

2.5 How it works

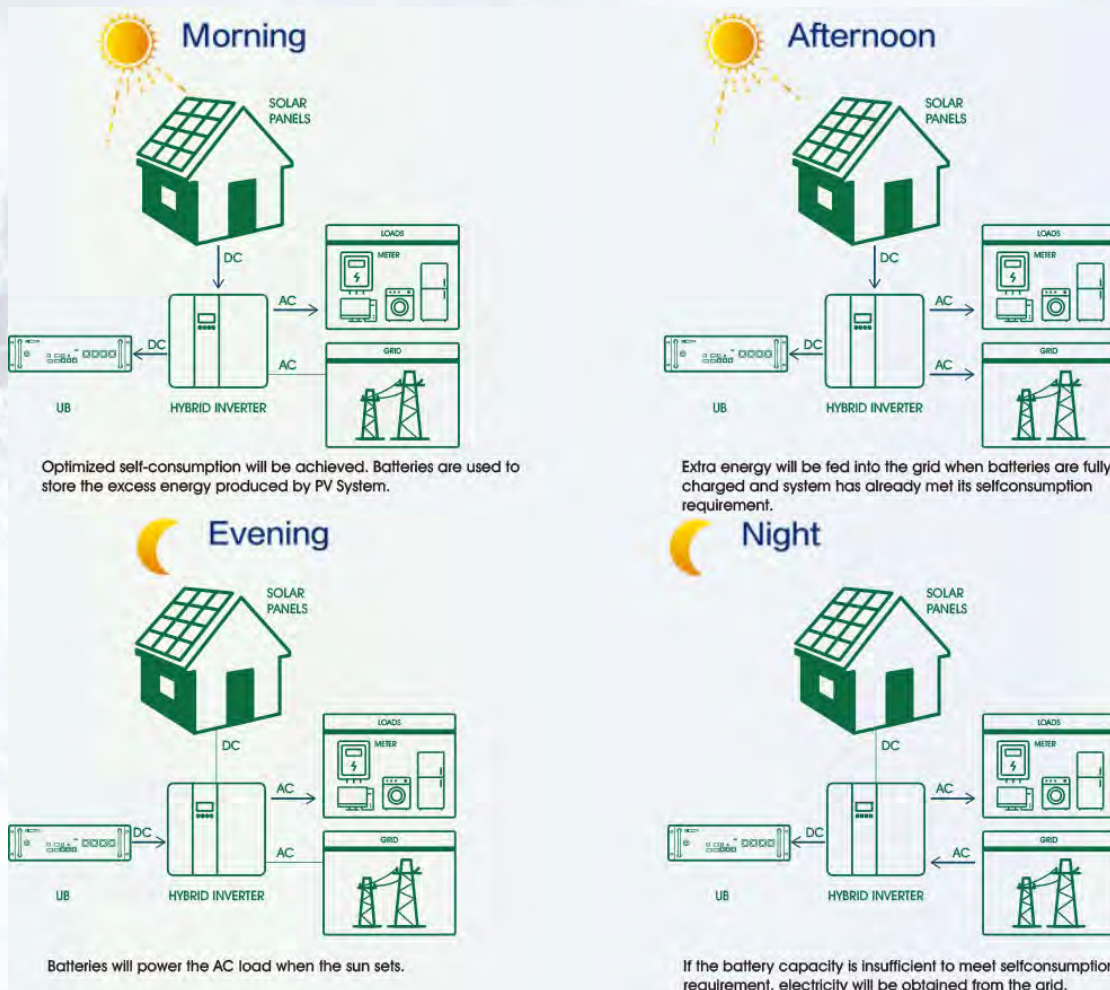

2.6 Feature

The UB Energy Storage battery has following features:

- **Energy storage unit:** This battery is suit for photovoltaic system compatibility.
- **Battery management system (BMS):** The battery built-in BMS monitors its operation and prevents the battery from operating outside design limitations. See **Troubleshooting on Chapter 8**.
- **Monitor:** The battery BMS built-in with WIFI module, the battery running information could be seeing in mobile phone and computer.
- **Easy firmware update:** The BMS firmware can be updated to the latest version. See **Chapter 9 Firmware Update** on page 27.
- **Expandability:** The battery capacity can be increased by adding another battery. See **part 5.4.2 Parallel connection** on page 20.

3. Guidance for disconnection of batteries during shipment

- 3.1 Cartons that have been crushed, punctured, or torn in such a way that contents are revealed shall be set aside in an isolated area and inspected by a skilled person. If the package is deemed to be not shippable, the contents shall be promptly collected, segregated, and either the consignor or consignee contacted.
- 3.2 The DC circuit of Ouco UB 5000 battery has been disconnected before outgoing.
- 3.3 A precautionary label had been affixed to the shipping carton to alert individuals as to the battery within the package have been disconnected; otherwise, the battery should not be transported.
- 3.4 We have conducted comprehensive tests to ensure the equipment they distribute around the world is safe for shipping transport. These products shall be handled with care and immediately inspected if visibly damaged. If the cartoon visibly damaged, please contract your distributor to confirm whether the battery could be used safely or not.

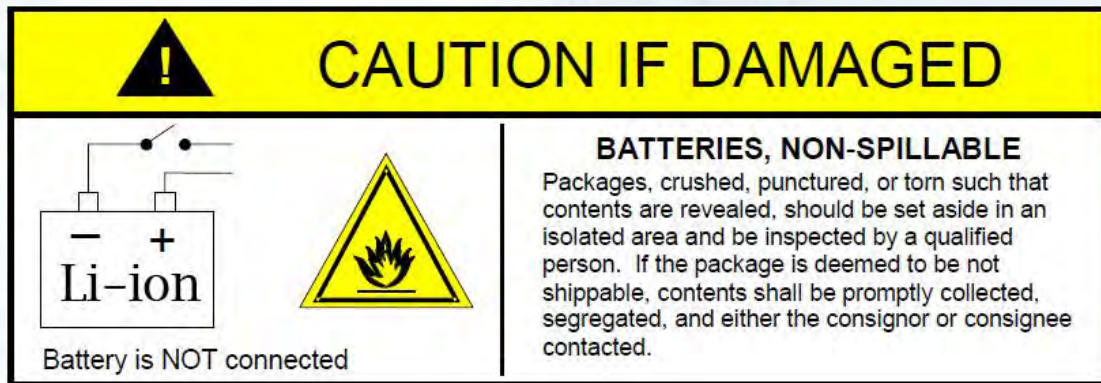

4. Installation Prerequisites

4.1 Installation location

Make sure that the installation location meets the following conditions:

- The building is designed to withstand earthquakes.
- Far away from the sea to avoid salt water and humidity.
- At least 2.5m far away from combustible.
- The installed location should not be access by pet and children.
- The floor is flat and level.
- No flammable or explosive materials nearby.
- Optimal ambient temperature is between 15°C and 30°C.
- Temperature and humidity stays at a constant level.
- Minimal dust and dirt in the area.
- No corrosive gases present, including ammonia and acid vapor.

If the ambient temperature is outside the operating range, battery will protect itself by shutting down. The battery optimal operate temperature is 15°C to 30°C. Frequent exposure to severe operating condition would exacerbate the performance and lifetime of the battery.

4.2 Installation requirements

For safety used of battery, please notice following notes when install:

- The installation shall be in a restricted access location/ room or in a cabinet where provides a barriers for the battery terminal.
- The maximum number of battery shall be not over 8 PCS, if the battery are connected in series, Or electric shock would happen.
- DVC class specification: DVC-C for battery terminal, DVC-A2 for all communication terminals.
- The insulation design for the battery is basic on voltage 450d.c. of OVC II and 230Va.c. of OVC III. Any connection to those greater than the design is not permitted.

4.3 Installation process

The battery should be installed according to the following flow chart. The detail installation process described in chapter **4 Install process**.

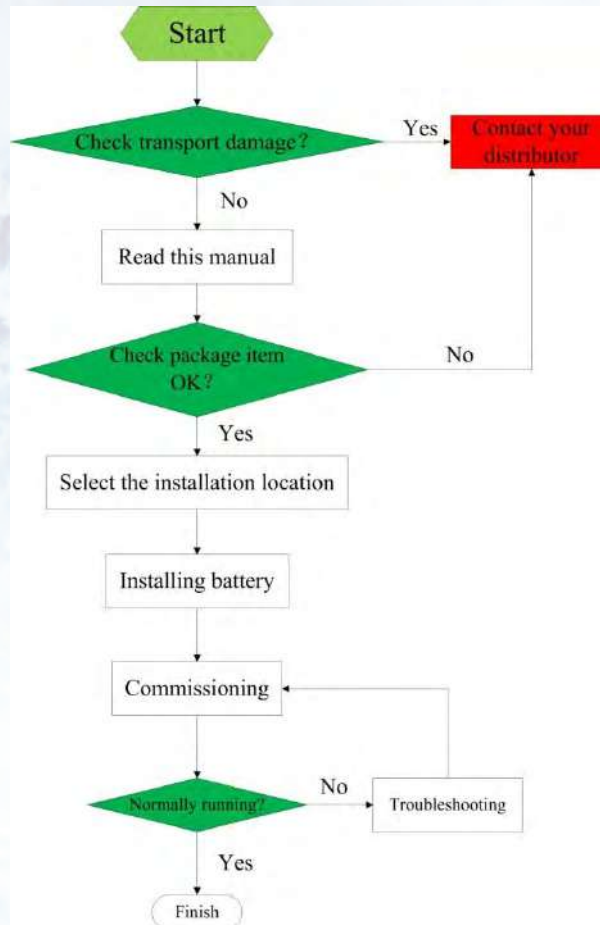

4.4 Installation materials

Following installation materials should be prepared by installers.

- Power cable
- Data cable
- Earth cable
- Ground wire
- Bipolar external isolator, when two or more battery systems in parallel, each of them shall have a bipolar isolator. Meanwhile, the isolator shall have ability to break the full load current.

NOTICE

Make sure that the cross-sectional area of charging cables is 25 to 35 mm².

NOTICE

A breaker between UB battery and inverter was recommended to install, and the breaker's min. current should be over 150A or following with local regulations.

4.5 Tools

To install the battery pack, those following tools are probably required:



Phillips screwdriver



Torque wrench

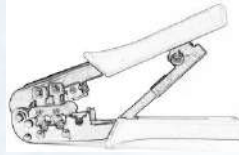

Cable crimper



Wire clamp



Voltmeter



Tape measure



Drill

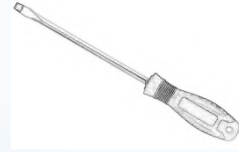

Flat-head screwdriver

In order to protect operator and installer's safety, please select and use suitable tools and measuring instruments that are certified for precision and accuracy.

4.6 Safety instruments

When dealing with the battery, following safety gears should be equipped. Installers must meet the relevant requirements of IEC 60364 or the domestic legislation and other relevant international standards.



Insulated glove

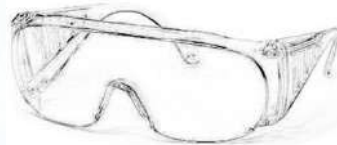

Safety goggles



Safety shoes

4.7 Network cable

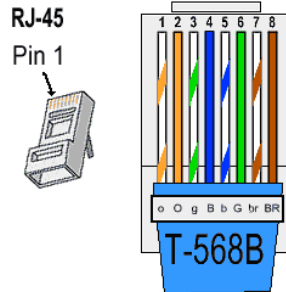

If needed, the network cable should be made like that diagram. But the network cable between battery and Inverter should be made following the definition of Inverter. If available, use a LAN cable tester to check whether the cable is faulty.

4.8 Storage

If the battery is not to be installed immediately, or removed from operation and needs to be stored for a long period, please choose an appropriate location to store it.

Instructions for storage are:

- Do not stack more than 8 battery boxes.
- The temperature of battery stored recommended in the range of -20°C to 25°C.
- Do not expose to water

The battery box should be upright as shown in the following figure and not stacked upside down when storing the battery box.



If the battery needs to be stored over 3 months, the DC circuit of battery suggests to be disconnecting. Otherwise, the battery would discharge at a minimum rate and capacity degrades depended on storage time, the battery self-consumption less than 5w. And, if the battery stored over 6 months, it is suggested to connect the battery with inverter and commission the system.

5. Battery Installation

5.1 Package items

These items are included in the package.



Battery*1



Cardboard*1



User Manual



Warranty

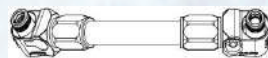

Battery link*2



Data Cable*1

5.2 Checks before installation

There are a few things to check before installing the battery to ensure that it has no defects.

Check item 1: Check the battery voltage.

WARNING

If this checking process is executed for any reason after the battery is fully installed, make sure that the inverter is turned off or break the connection between battery and inverter while checking the battery.



Press and hold the panel button for about 4s and then release it after the two LED lights on, measure the voltage at the terminal interface with a voltmeter. If the voltage is lower than 48 V, do not use the battery and contact your distributor.

5.3 Installation the battery

NOTICE



The symbol located on the front of battery, and the earth wire between battery and inverter is compulsive for Series Connection. For Parallel connection, the earth wire was also required to be installed.

5.3.1 Connect with 48Vdc Inverter

To prevent the battery from moving, make sure the battery fixed to a wall.

NOTICE

If the battery is installed above the floor or on a platform, make sure that the wall or platform is capable of supporting the battery's weight.

5.3.1.1 Wall mounting

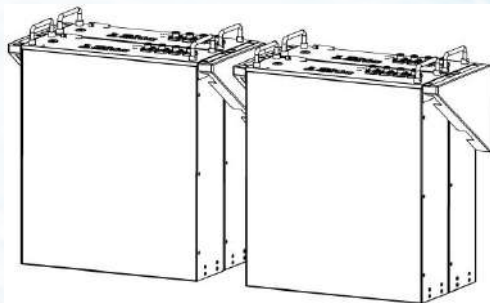
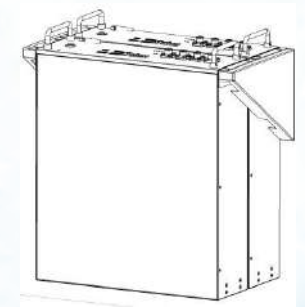
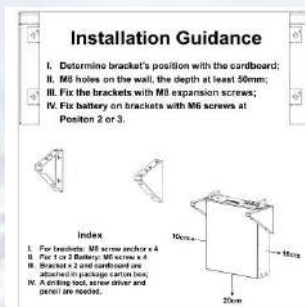

1. Determine bracket mounting place to be fixed using this Positioning cardboard.
2. Drill holes in the wall for the M8 expansion screw anchors, which depth should be at least 50 mm. Tighten the screws to a torque around 2.5 N·m.
3. Fasten the battery to bracket fasten hole with M6 screws with 2.0N·m roughly.
4. Meanwhile, two or four batteries could be installed by these brackets.

Note: if more than 4 batteries installed, a cabinet recommended to be selected for the battery's stable.

The installed location shall be restricted access or installed in a cabinet which provides a guard from pet and children.

5.3.1.2 Ground installation

Meanwhile, UB 5000 battery also could be installed on floor, the installation step as following:

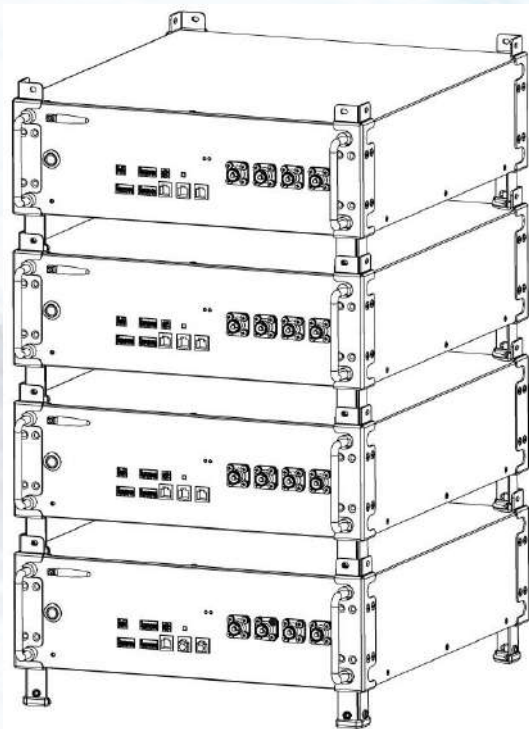
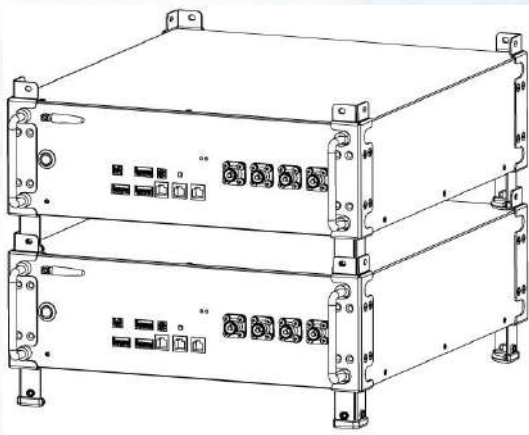
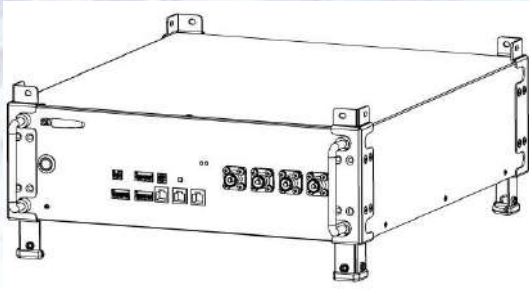
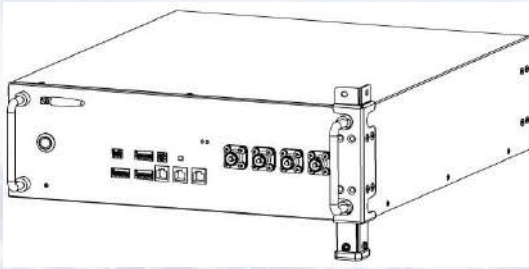

1. Fix the braced feet to battery's mounting holes one by one.

2. If more power and energy needed, two or more (less than 4) batteries could be installed in one stack.

3. But if the number of batteries at the range of 4~8, a cabinet recommended to be selected.

5.3.2 Address select of Master and Slave battery(ies) connection

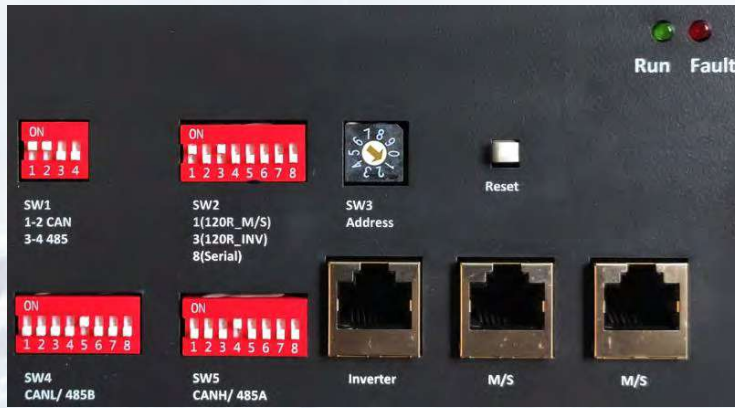

For Series connection, please make sure the SW2 DIP switch of selected as this type.

WARNING

Please make sure the SW2 DIP switch selected correctly, if the battery connected in Parallel mode, but select SW2 DIP8 at ON position, probably lead serious fault even dangerous. Meanwhile, if battery connected in Series mode select SW2 DIP8 at OFF status, serious fault and dangerous probably occurred.

Connected battery number	Group	Set of SW2		Address Set (SW3)
		Series connect	Parallel connect	
1	—			
2	Master			
	Slave			
3	Master			
	Slave 1			
	Slave 2			
4	Master			
	Slave 1			
	Slave 2			
	Slave 3			
5	Master			

	Slave 1			
	Slave 2			
	Slave 3			
	Slave 4			
6	Master			
	Slave 1			
	Slave 2			
	Slave 3			
	Slave 4			
	Slave 5			
7	Master			
	Slave 1			
	Slave 2			
	Slave 3			
	Slave 4			
	Slave 5			
	Slave 6			
8	Master			
	Slave 1			
	Slave 2			
	Slave 3			
	Slave 4			

	Slave 5			
	Slave 6			
	Slave 7			
9	Master			
	Slave 1			
	Slave 2			
	Slave 3			
	Slave 4			
	Slave 5			
	Slave 6			
	Slave 7			
	Slave 8			
10	Master			
	Slave 1			
	Slave 2			
	Slave 3			
	Slave 4			
	Slave 5			
	Slave 6			
	Slave 7			
	Slave 8			
	Slave 9			

5.4 Cable connections

WARNING

Before connecting battery with inverter, please make sure that no inverter connected or the inverter turned off.

5.4.1 Cable connection for **Series connection**

NOTICE

The voltage difference of each battery should be less than 100mV.

5.4.1.1 Ground installation

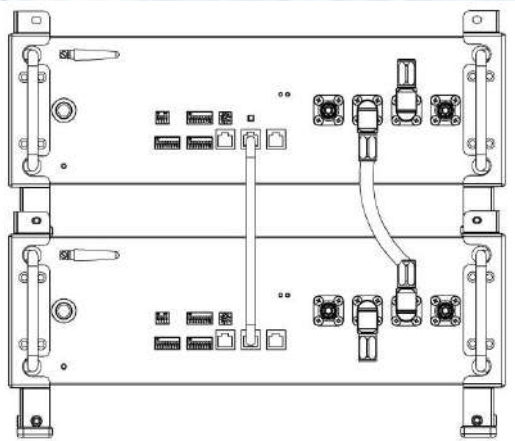

Feed a data cable to M/S communication terminal interface one by one directly.

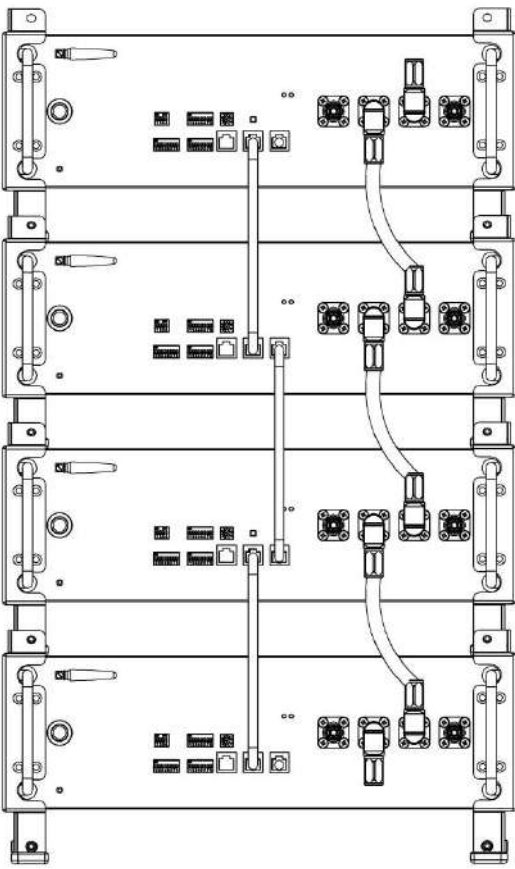

If more than 4 batteries installed, a cabinet was recommended.

5.4.1.2 Wall mounting

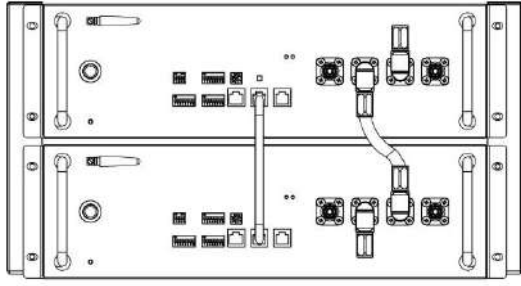

For wall mounting, the battery Series connection number should be less than 4, if more batteries installed, a cabinet was recommended.

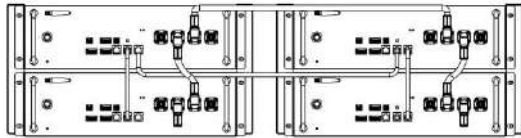

NOTICE

If battery connected in Series mode, it's better to be installed in Ground installation method, for the Power cable resistance difference between stack and battery pack, which will have fade effect on voltage balance.

5.4.2 Cable connection for **Parallel connection**

5.4.2.1 Ground installation

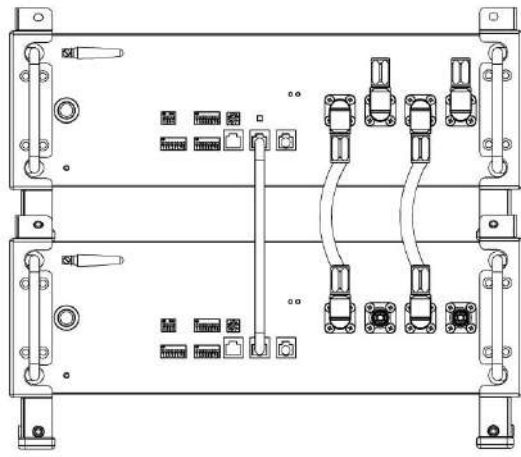

For parallel installation, please pay attention on Cable connection, and the DIP8 of SW2 no need to be changed and stayed on Initial Factory state.

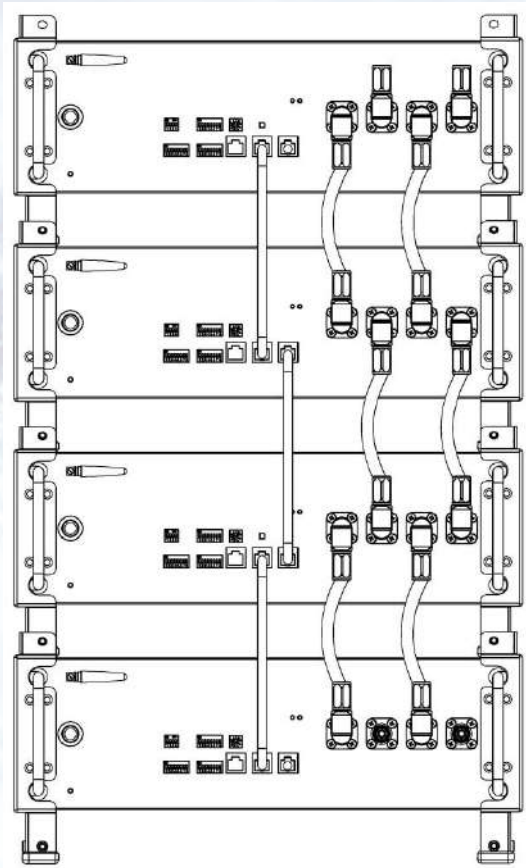

5.4.2.2 Wall mounting

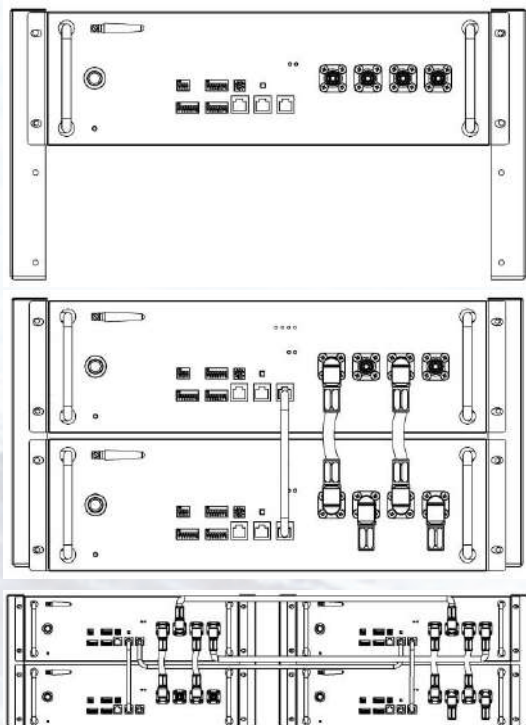

For wall mounting, the battery Series connection number should be less than 4, if more batteries installed, a cabinet was recommended.

NOTICE

Before two or more batteries installed in parallel, please check the voltage of each battery and make sure the voltage different less than 1.0V.

6. Configuration

DIP switch should be set correctly for proper communication between inverter and battery.

If parallel connecting multiple batteries, please set the DIP switches as following:

6.1 Configure device WIFI

The UB battery has a built-in WIFI module for use with the **Ouco** APP.



The WIFI setting of battery should be as following

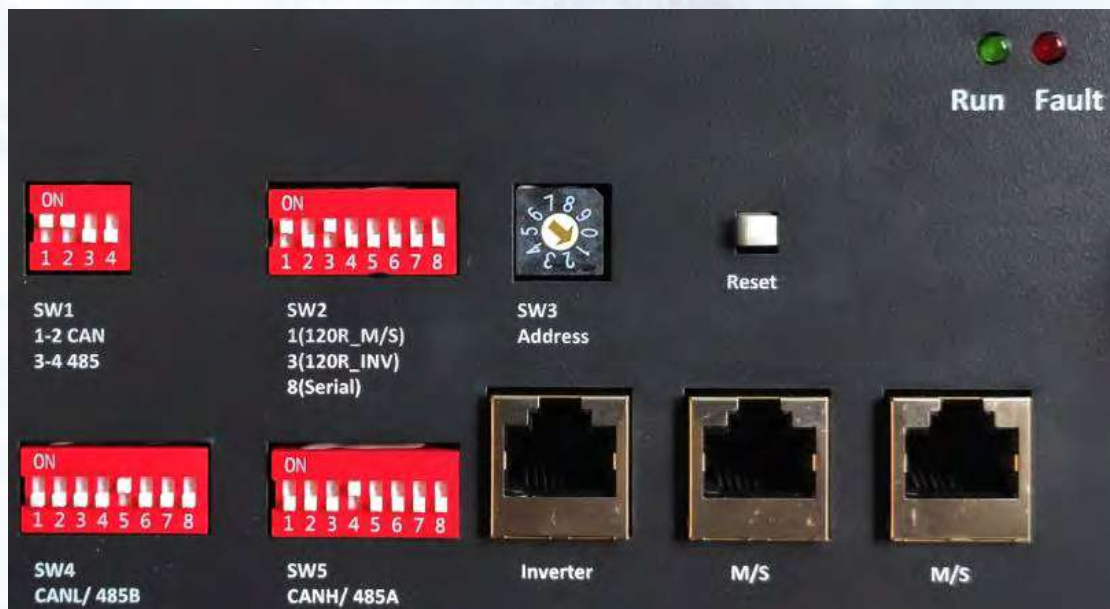

1. Press and hold the Reset button for 7 seconds.



2. Connect the „USR-WIFI232-XX_XXXX“ with your smart phone, and then the light of WIFI will turn on by itself within 5 seconds.
3. Open the APP monitor of battery, select „Config Device Wifi“ option box.



4. Search and select SSID connected and input the password, press ok and finish. The light of WIFI module would light automatically under WLAN accessible condition.

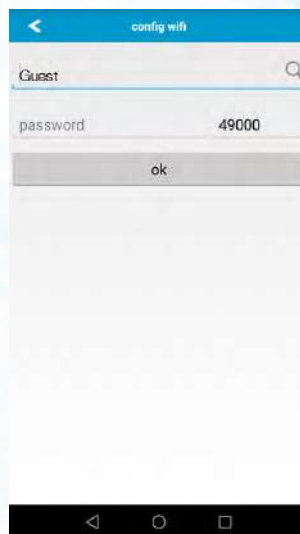

NOTICE

If the WIFI cannot be set or there is no WLAN accessible, the battery can still operate normally.

6.2 Register your account

NOTICE

The UB battery could be registered only one time.

1. Open the APP monitor of battery, select „Register“ option box.

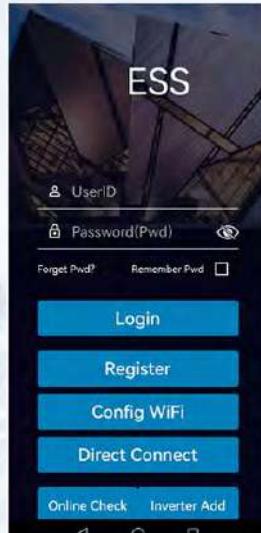

2. After scanning the bar code of battery, there are some personal messages need to be filled which noted by “*” symbol.

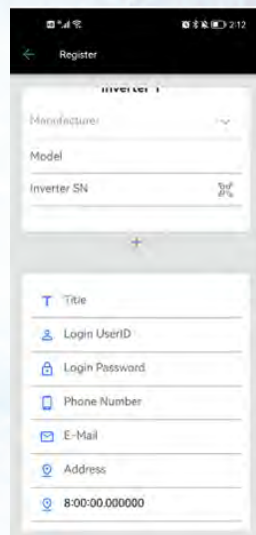

3. After those messages filled and signature, the APP would jump to the running interface automatically.

NOTICE

The UB battery running is not associated with registration or not.

6.3 Settings for CAN /485 bus pins

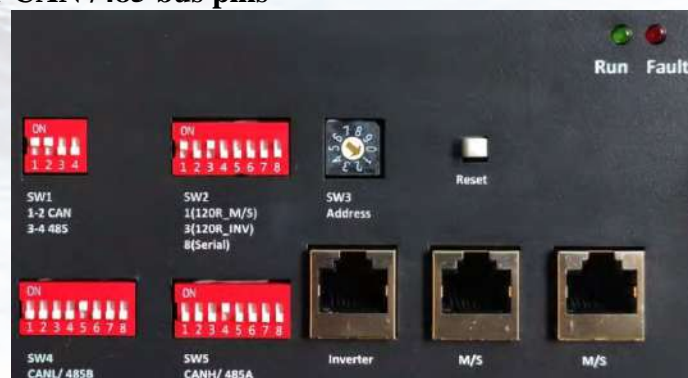

Confirm that the CANL/485B DIP switch is set to SW2 which pin is used for CAN high signal by inverter (4-CANH/485A), and the CANL/485B DIP switch is set to SW1 which pin is used for CAN low signal by inverter (5-CANL/485B).

As SW3 the CAN/485 GND DIP switch, installer should confirm which pin is used for ground by inverter or not.

NOTICE

The battery default protocol is CAN bus, if an inverter communication mode is RS485 or other protocol, please contact your distributor before installed the battery.

7. Commissioning

7.1 Commissioning battery

If there is only one battery installed, use the following steps to put it in operation:

1. Press and hold the panel button on the left side of the unit for about 4s, after the green lights on, release the panel button.
2. Make sure that the red light is on. If the red light is on, do not use the battery and contact to your distributor.
3. Turn the inverter on, and wait for the start-up sequence to complete fully.

When there are two or more batteries connected with parallel mode, after the charging cable and the data cable has been connected correctly, follow these steps to put them in operation:

1. Check battery voltage level is above 48V
 - a) If battery voltage is under 45V contact your distributor for help.
2. Press and **HOLD** the panel button for about 4s, after four seconds the indicator lights will turn on.
3. Release the panel button.
 - a) For all batteries, make sure that the Run light is on.
 - b) Make sure the maximum voltage different between batteries less than 1.0V.
 - c) If not, the installer should balance the battery voltage and then parallel connect batteries together.
 - d) Set the DIP switches like part **6-1 Setting for communication interface**.
4. Turn the inverter on, and wait for the start-up sequence to complete fully.

7.2 Shutting down battery

Shut down the battery only when the battery is no charge or discharge current which could be seen in your smart phone with APP.

1. Press and hold the Panel Button about 8s, after a disconnect voice of relay come can release it.
2. Make sure that every light on the battery is off.

8. Troubleshooting

1. Every fault is presented by a fault code. If the battery fault light is on, please check the Fault code in Homepage.
2. If the battery fault light on, pls check the Troubleshooting number in Homepage in your Ouco APP, if the code is 0x1***, this problem would be recovered by itself. But if the code is 0x2*** or 0x3***, please contact your distributor for help.
3. If the information of battery cannot be seen in the monitoring system, check the battery status first. If the battery status is OFF, please turn the battery on, and then check the WLAN is accessible for battery.
4. If Register the battery failure, please check the network of mobile phone nearby the battery installation site available and stable.

Table 8-1 Fault Code of Battery

Fault Code	Detail fault message
0x1001	Battery under voltage warning
0x1002	Battery over voltage warning
0x1003	Battery under temperature warning
0x1004	Battery over temperature warning
0x1005	Battery charge over current warning
0x1006	Battery discharge over current warning
0x1007	Cell over discharge warning
0x1008	Cell over charge warning
0x1009	Battery charge with over temperature warning
0x1010	Battery discharge with over temperature warning
0x1011	Battery charge with under temperature warning
0x1012	Battery discharge with under temperature warning
0x2001	Battery under voltage protect
0x2002	Battery and cell over discharge protect
0x2003	Battery over charge protect
0x2004	Battery over voltage and cell over charge protect
0x2005	Battery under temperature protect
0x2006	Battery over temperature protect
0x2007	Battery charge over current protect
0x2008	Battery discharge over current protect
0x2009	Cell over discharge protect
0x2010	Cell over charge protect
0x3000	Communication broken between master and slave Battery
0x3001	Address select fault

9. Firmware Update

It is possible to update the BMS firmware version manually via the WIFI monitor system App.

After a new firmware version is uploading to the server, the firmware could be updated over the Internet by itself after holder confirmed.

Step 1:

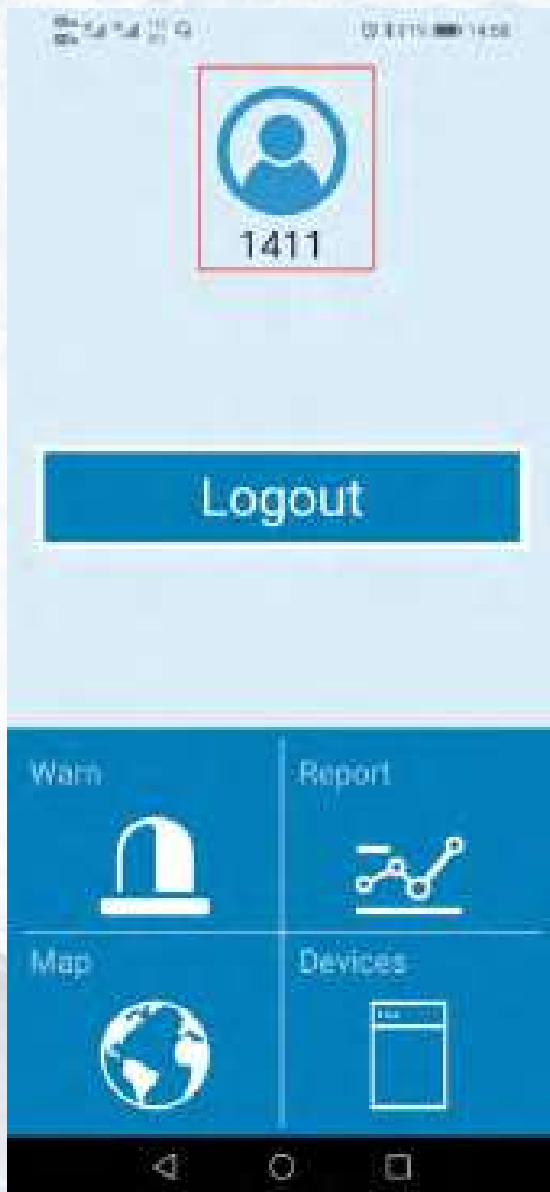

Step 2:



Step 3:



Step 4:

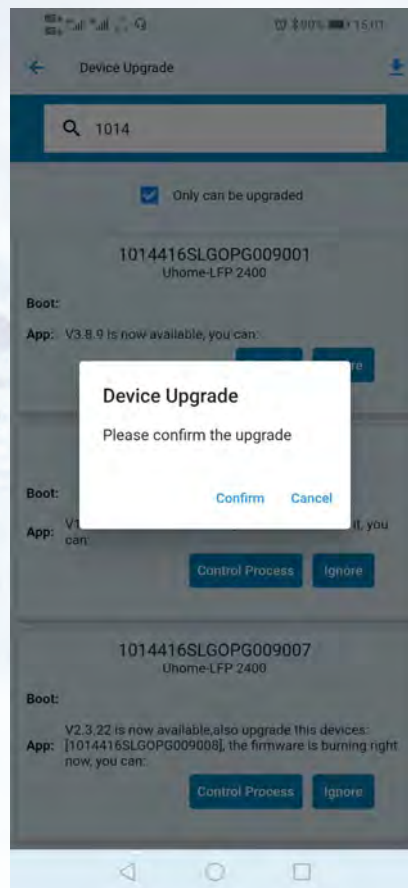

Step 5:

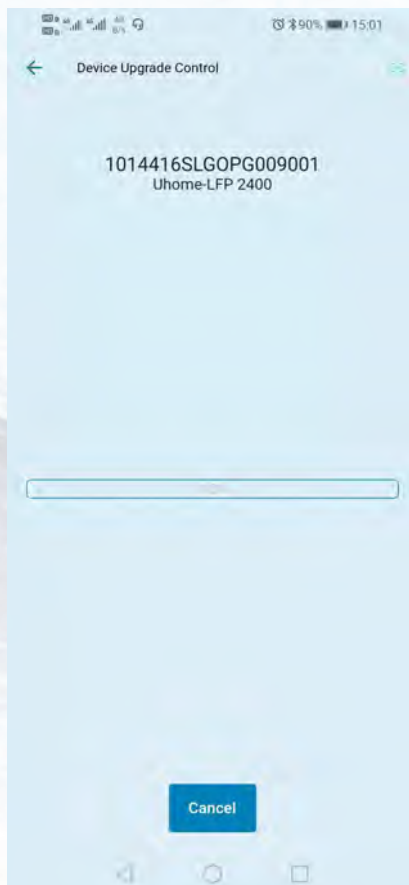



Our Environment, Our Energy, Our Future

